

EM SERIES

Digital Platform Scale

A&D Company, Limited

1WMPD4002222

1. INTRODUCTION

This manual describes how the EM Series Digital Platform Scales work. Please read this manual completely before using the scale.

1.1. Precautions

- CAUTION**
- The scale is a precision instrument. When installing the scale, consider the following conditions to get the most out of your scale.
 - Install the scale where it is not exposed to direct sunlight, where the temperature and relative humidity is stable and where there is no dust and draft.
 - Install the scale on a solid and level surface which is free from vibration.
 - The scale is not waterproof. Do not use it where it will get wet.
 - Do not disassemble the scale. Do not open the case to repair or modify it. That may cause a fire or damage to the scale. Damage caused under such conditions will void the warranty.
 - If the scale malfunctions, stop using it immediately. Contact the local A&D dealer.

1.2. Features

- The EM series digital platform scales have the following features.
- Three weight display resolutions are available, normal (1/3000), high (1/6000 to 1/7500) and higher (1/12000 to 1/15000).
 - Two weighing platform sizes are available. The EM-KAM has a smaller pan and the EM-KAL has a larger pan.
 - As a power source, either the AC adapter or internal rechargeable battery can be used.
 - The counting function easily counts the number of objects of the same weight.
 - The optional serial interface can transmit the weight value to a personal computer or a printer.

1.3. Unpacking

When unpacking, check whether all of the following items are included.

- The EM series scale with screws and nut • AC adapter • Instruction manual

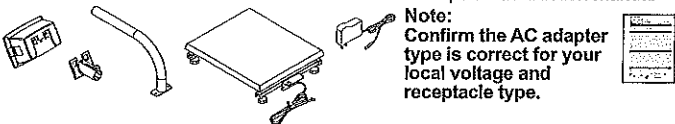

2. DESCRIPTION OF EACH PART

EM series (Common for all models)

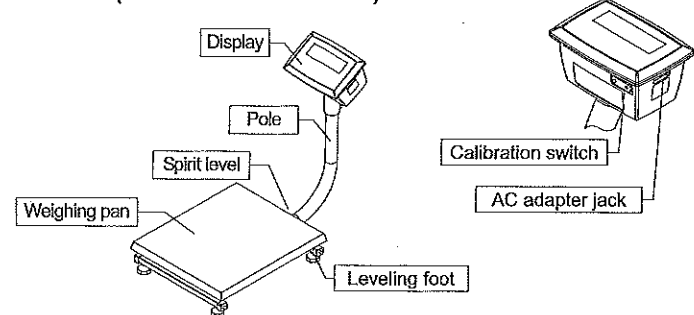

Display and symbols

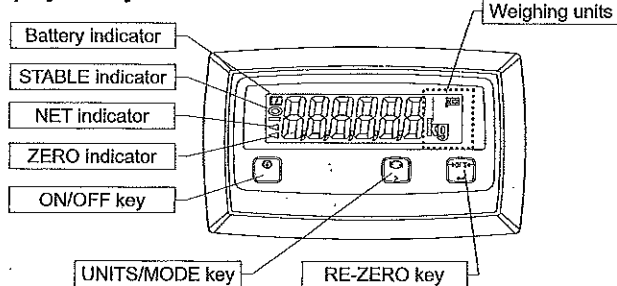

STABLE	●	Turns on when the weight value is stable.
NET	◀	Turns on when the NET weight is displayed. (The tare operation is in progress.)
ZERO	◀	Turns on when the scale shows zero.
Weighing units	kg pcs	"kg": Basic weighing mode in kg. "pcs" (pieces): Counting mode which determines a unit weight (the weight of one piece) from the known pieces of samples and calculates how many pieces are on the weighing pan using the unit weight.
Battery indicator	▢ ▢ ▢ ▢ ▢ ▢ ▢ ▢ ▢ ▢	Changes as the battery capacity decreases as shown to the left.

3. INSTALLATION

3.1. Setting up the Scale

- Step 1 Pass the cable B through the pole.
- Step 2 While taking care not to pinch the cable, secure the pole to the weighing platform, using two screws.
- Step 3 Secure the bracket to the pole, using a nut and screw.
- Step 4 Connect cable A to cable B.
- Step 5 Bundle the excess cable and insert it into the pole.
- Step 6 Attach the display to the bracket.

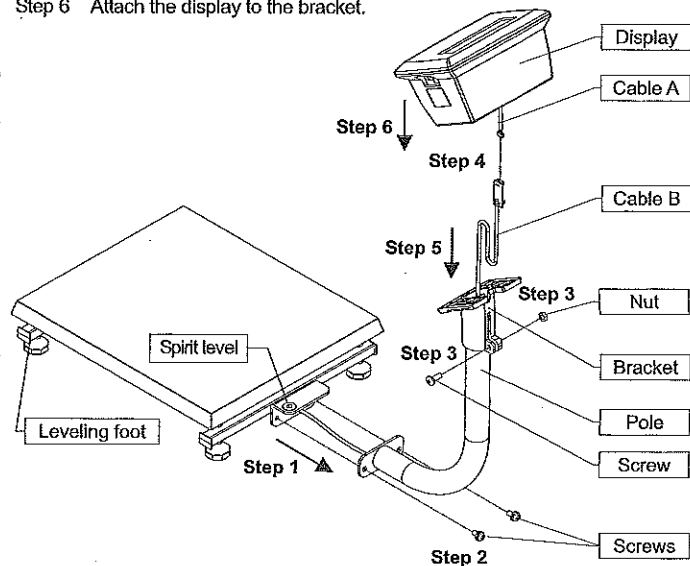

3.2. Installing the Scale

- Adjust the level of the scale, using the leveling feet. Confirm that the bubble of the spirit level is in the center of the level.
- The best installation conditions are: stable temperature (-10°C to 40°C) and relative humidity (less than 85%), solid and level surface, no drafts or vibration, no direct sunlight.
- Do not install the scale where there may be static electricity or sudden changes in temperature.

4. BASIC WEIGHING OPERATION

- Step 1 Press the **ON/OFF** key to turn the power ON. The display shows "----" if there is something placed on the weighing pan or the scale is unstable.
- Step 2 Press the **UNITS/MODE** key to select "kg" (kg mode).
- Step 3 When the display doesn't show zero, press the **RE-ZERO** key.
- Step 4 When a tare (container) is used, place the container on the weighing pan and press the **RE-ZERO** key to set the display to zero.
Scale weighing range = weighing capacity - tare weight
- Step 5 Place the object to be weighed on the weighing pan or in the container. Wait for the STABLE indicator to turn on and read the value.
- Step 6 Remove the object from the weighing pan.
- Step 7 Press the **ON/OFF** key to turn the power OFF. When the auto power-off function is enabled, the scale turns off automatically after 5 minutes of stable condition (zero display).

5. COUNTING MODE

- Step 1 Press the **UNITS/MODE** key to select "pcs".
- Step 2 Press and hold the **UNITS/MODE** key to enter the sample unit weight storing mode. (The figure on the left is the number of samples.)
- Step 3 To change the number of samples, press the **ON/OFF** key. It may be set to 5, 10, 20, 50 or 100.
- Step 4 If necessary, place a container on the weighing pan and press the **RE-ZERO** key. Confirm that the right side of the number of samples shows zero.
- Step 5 Place the correct number of samples on the weighing pan or in the container. In this example, place 20 pieces of samples.
- Step 6 Confirm that the **STABLE** indicator is turned on. Press the **UNITS/MODE** key to calculate and store the unit weight. Remove the samples. The unit weight is stored in memory, even if the power is turned off.

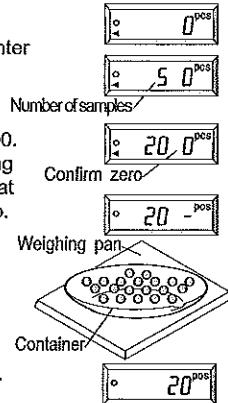

Note



- The total weight of samples should be more than shown below, regardless of the number of samples.
Weighing capacity of 30 kg: 100 g, capacity of 60 kg: 200 g, capacity of 150 kg: 500 g
If not, the display shows "Lo ut" and returns to the display of step 5. Increase the number of samples (step 3) and try again.

6. CALIBRATION

This function adjusts the scale for accurate weighing. Calibrate the scale when it is first used, when it has been moved, when the ambient environment has changed or for regular calibration.

Note:

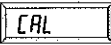
- Before calibration using a weight, set the gravity acceleration value to that of the current location.

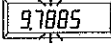
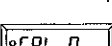
- Step 1 Press the **ON/OFF** key to turn the power on. 
- Step 2 Press the Calibration switch to display "CAL". 
- Step 3 To perform a calibration using a weight, press the **RE-ZERO** key to display "CAL 0". Go to step 4. 
To compensate the gravity acceleration value, press the **UNITS/MODE** key to display the gravity acceleration value (example "9.7885"). Go to step 7. 

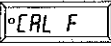

Calibration using a weight (from step 3)

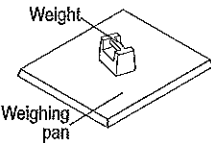
- Step 4 Confirm that nothing is placed on the weighing pan and the STABLE indicator is turned on. Press the **RE-ZERO** key. The scale calibrates the zero point and displays "CAL F". If you do not need SPAN calibration, turn the power off. 

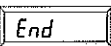
- Step 5 Place a calibration weight on the pan with the same value as the weighing capacity. When multiple weights are placed in stacks, the scale may be unstable due to the high position of center of gravity. Stop the motion of scale by temporarily holding the pan. 

- Step 6 Wait for the STABLE indicator to turn on. Press the **RE-ZERO** key. The scale calibrates SPAN, displays "End" and returns to the weighing mode. Remove the weight. The display shows zero automatically. 

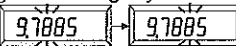
Gravity acceleration correction (from step 3)

- Step 7 Change the gravity acceleration value using the following keys.
UNITS/MODE : To shift the blinking digit. 
RE-ZERO : To increase the value of the blinking digit by one. 

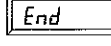
- Step 8 Press and hold the **UNITS/MODE** key and press the **RE-ZERO** key. Then, release the **UNITS/MODE** key. "End" is displayed and the new value is stored. 

For further information on calibration, contact the local A&D dealer.

7. FUNCTION SETTING

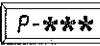
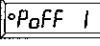
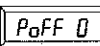
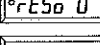
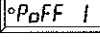
- Step 1 Press the **ON/OFF** key to turn the power off. 
- Step 2 Press and hold the **RE-ZERO** key and press the **ON/OFF** key. The software version is displayed. "***" indicates the software version number.
- Step 3 Press the **UNITS/MODE** key to display the first item. "P OFF 1" indicates the current setting. 
- Step 4 Change the item or parameter using the following keys.
UNITS/MODE : To display the next item 
RE-ZERO : To increase the parameter value by one 

- Step 5 When the parameter is changed (the STABLE indicator is turned off), press the **UNITS/MODE** key to store the change. After "End", the next item is displayed.

Item	Parameter	Description
Auto power-off function PoFF	0	Auto power-off disabled
	1	Auto power-off enabled
Display resolution rESo	0	Normal (1/3000)
	1	High (1/6000 to 1/7500)
	2	Higher (1/12000 to 1/15000)
Zero tracking function trc	0	Zero tracking disabled
	1	Zero tracking enabled
Decimal point dP	0	Dot (.)
	1	Comma (,)
Serial interface Baud rate bPd	0	2400 bps
	1	4800 bps
	2	9600 bps
Serial Interface Data output mode PrL	0	Stream mode
	1	Command mode
	2	Not used
	3	Not used
Backlight Lit	0	Auto
	1	Always on
Initialization in it	0	Always off
	2	Always on
		Restores the settings to the factory setting values. Read "7.1. Initialization".
		Factory setting

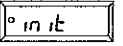
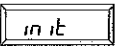
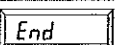
7.1. Initialization

- Step 1 Follow the function setting procedure to display "in it". 
- Step 2 Press the **RE-ZERO** key. The STABLE indicator turns on. 
- Step 3 Press the **UNITS/MODE** key. The scale displays "End". The function settings have restored to the factory setting values. 

8. MAINTENANCE

8.1. Notes on Maintenance

- Do not disassemble the scale. Contact your local A&D dealer if the scale needs service or repair.
- Use the original packaging for transportation.
- The scale is not waterproof. Ensure no water is allowed inside the scale.
- Use the scale under the specified operating conditions: Temperature of -10°C to 40°C, relative humidity of less than 85% without condensation.
- The rechargeable battery naturally self-discharges without usage. Do not leave the battery for more than 30 days in storage and charge the battery periodically.

8.2. Error Display

- E** Indicates that an object beyond the weighing capacity has been placed on the weighing pan. Remove the object.
- E** Indicates that the weight sensor received strong force upward. There is a possibility that the weight sensor or internal circuit have a failure.
- Lo ut** Indicates that the sample weight is too light to set the unit. Increase the number of samples.
- Lb** Indicates that the battery is depleted. Charge the battery.
- Hb** Indicates that the voltage of the AC adapter is too high. Use the specified AC adapter.
- Error *** The internal circuit may have a failure. ("*" indicates the error number.) Contact the local A&D dealer.

If the errors described above can not be released or other errors are displayed, contact the local A&D dealer.

9. SPECIFICATIONS

9.1. Specifications

Model	EM-30KAM	EM-60KAM / EM-60KAL	EM-150KAL
Weighing capacity	30 kg	60 kg	150 kg
Minimum display "d"	10 g	20 g	50 g
	5 g	10 g	20 g
	2 g	5 g	10 g
Maximum count (Counting mode)	30000 pcs		
Minimum unit weight	1 g	2 g	5 g
Repeatability (Standard deviation)	±5 g	±10 g	±20 g
Linearity	±10 g	±20 g	±50 g
Sensitivity drift	±0.01%/°C (5°C to 35°C)		
Display	7-segment LCD with backlight, Character height of 26 mm		
Display update rate	Approximately 10 times per second		
Operating conditions	-10°C to 40°C, 85%RH or less, No condensation		
Power supply	AC adapter or rechargeable battery Confirm the AC adapter type is correct for your local voltage and receptacle type.		
Battery life	Approximately 80 hours when used at 20°C		
Weighing pan size	EM-KAM: 300x350 mm / EM-KAL: 400x500 mm		
Dimensions	EM-KAM: 300x560x450 mm / EM-KAL: 400x710x750 mm		
Mass (approximately)	EM-KAM: 4 kg EM-60KAL: 7 kg / EM-150KAL: 9.6 kg		
Calibration weight	30 kg	60 kg	150 kg

9.2. Option

OP-03 (EM-03) serial interface is available for the EM series as an option.

A&D
A&D Company, Limited
 3-23-14 Higashi-Ikebukuro, Toshima-ku, Tokyo 170-0013 JAPAN
 Telephone: [81] (3) 5391-6132 Fax: [81] (3) 5391-6148

A&D ENGINEERING, INC.
 1756 Automation Parkway, San Jose, California 95131 U.S.A.
 Telephone: [1] (408) 263-5333 Fax: [1] (408) 263-0119

A&D INSTRUMENTS LIMITED
 Unit 24/26 Blacklands Way, Abingdon Business Park, Abingdon,
 Oxfordshire OX14 1DY United Kingdom
 Telephone: [44] (1235) 550420 Fax: [44] (1235) 550485

A&D Australasia Pty Ltd.
 32 Dew Street, Thebarton, South Australia 5031 AUSTRALIA
 Telephone: [61] (8) 8301-8100 Fax: [61] (8) 8352-7409